



User's manual

CL2940

Big button/big display telephone
with speakerphone/caller ID/
call waiting



Congratulations

on your purchase of this AT&T product. Before using this AT&T product, please read **Important safety information** on page 43 of this user's manual. Please thoroughly read the user's manual for all the feature operations and troubleshooting information necessary to install and operate your new AT&T product. You can also visit our website at **www.telephones.att.com** or call **1 (800) 222-3111**. In Canada, dial **1 (866) 288-4268**.

Model number: CL2940

Type: Big button/big display telephone with speakerphone/caller ID/
call waiting

Serial number: _____

Purchase date: _____

Place of purchase: _____

Both the model and serial numbers of your AT&T product can be found on the bottom of the telephone base.

Save your sales receipt and original packaging in case it is necessary to return your telephone for warranty service.



Telephones identified with this logo have reduced noise and interference when used with most T-coil equipped hearing aids and cochlear implants. The TIA-1083 Compliant Logo is a trademark of the Telecommunications Industry Association. Used under license.

Audio Assist® is a registered trademark of Advanced American Telephones.

© 2012 Advanced American Telephones. All Rights Reserved. AT&T and the AT&T logo are trademarks of AT&T Intellectual Property licensed to Advanced American Telephones, San Antonio, TX 78219.

Parts checklist

Your telephone package contains the following items. Save your sales receipt and original packaging in the event warranty service is necessary.



Handset



Telephone base

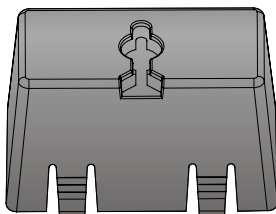

Mounting bracket



Coiled handset cord



Telephone line cord

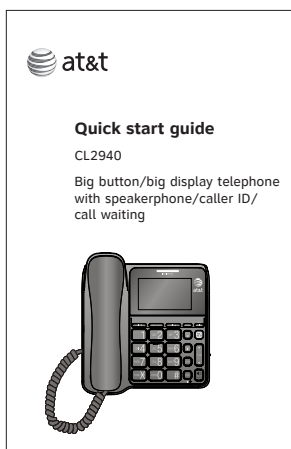

Quick start guide

User's manual

CL2940

Big button/ big display
telephone with speakerphone/
caller ID/call waiting



Table of contents

Getting started

Quick reference guide	1	Options while on call.....	17
Installation.....	3	Volume control.....	17
Battery installation.....	4	Call waiting.....	17
Telephone installation	6	Mute.....	17
Installation options.....	7	Chain dialing	18
Tabletop to wall mount		Audio Assist®	19
installation.....	7	Temporary tone dialing.....	19
Wall mount to tabletop			
installation.....	9		

Telephone settings

Telephone settings	11
Set date and time.....	11
Contrast.....	12
Dial mode	12
Language	13
Home area code.....	13
Local area code	14

Telephone operation

Telephone operation.....	15
Making a call.....	15
On hook dialing (predialing).....	15
Answering a call.....	15
Ending a call.....	15
Speakerphone.....	15
Last number redial.....	16
Ringer volume	16

Directory

Directory	20
Directory memory capacity.....	20
Character chart.....	20
Create directory entries.....	21
Store a directory entry.....	21
Review the directory.....	22
Review directory entries.....	22
Search by name.....	22
Dial or edit directory entries	23
Dial a directory number.....	23
Edit a directory entry.....	23
Delete directory entries	24
Delete a directory entry	24
Speed dial	25
Speed dial memory overview	25
Store a speed dial entry.....	25
To review a speed dial number ..	26
To dial a speed dial number.....	26
To edit a speed dial number	27
To delete a speed dial number....	27

Caller ID

About caller ID	28
Information about caller ID with call waiting	28
Caller ID history	29
How the caller ID history (caller ID log) works	29
Missed (new) call indicator	29
Caller ID operation	30
Memory match	30
Review the caller ID history	31
View dialing options	31
Dial a caller ID log entry	32
Delete call ID log entries	32
Save a caller ID log entry to the directory	33
Save a caller ID log entry to a speed dial memory location	34
Reasons for missing caller ID information	35

Appendix

Screen messages and icons	36
Screen icons	36
Screen display messages	37
Troubleshooting	38
General product care	42
Important safety information	43
Safety information	43
FCC and ACTA information	44
Part 15 of FCC rules	45
Limited warranty	46
Technical specifications	48

Index

Index	49
-------------	----

Quick reference guide

MENU/SELECT

Press to enter the main menu (page 11).
While using the menu, press to accept the current setting, and move to the next menu option (page 11).
While reviewing the call history, press to store the displayed name and number in the directory (page 33).
While reviewing the directory, press to edit the displayed entry (page 23).

DIR▲

Press to enter the directory (page 22).
While using the menu, press to scroll through the settings (page 11).
While reviewing directory, speed dial memory or caller ID history, press to scroll up (pages 22, 26 and 31 respectively).
While entering names or numbers, press to move the cursor to the right.

CID▼

Press to review the call log (page 31).
While using the menu, press to scroll through the settings (page 11).
While reviewing the directory, speed dial memory or caller ID history, press to scroll down (pages 22, 26 and 31 respectively).
While entering names or numbers, press to move the cursor to the left.

Extra large tilt display

Adjust the viewing angle to reach maximum visibility.

CANCEL

Press to cancel an operation.
Press to return to the previous menu.
Press and hold to return to idle mode.
When the telephone is idle, press and hold to clear the missed call indicator (page 29).

DELETE X

When the telephone is idle, press and hold to clear the caller ID history (page 32).
While reviewing the directory, speed dial memory or caller ID history, press to delete an individual entry (pages 24, 27 and 32 respectively).

SPEED DIAL

Press to access the speed dial memory (page 26).
Press to store a caller ID entry in a speed dial memory location (page 34).

(pound key)

Press repeatedly to show other dialing options while reviewing a caller ID entry (page 31).

FLASH

During a call, press to answer an incoming call if you subscribe to a call waiting service provided by your telephone service provider (page 17).

MUTE

During a call, press to mute the handset or speakerphone. Press again to resume your conversation (page 17).



Quick reference guide



REDIAL/PAUSE

While using the handset or speakerphone, press to dial the last number dialed (page 16).
While the telephone is idle, press to display the last number dialed (page 16).
While entering numbers, press to insert a three-second dialing pause.

AUDIO ASSIST

Voices will sound louder and clearer if you press **AUDIO ASSIST** while you are on a call using the handset (page 19).

▲VOLUME▼

While on a call, press to adjust the listening volume (page 17).

RINGER VOL -/+

Slide to decrease or increase the ringer volume (page 16).

🔊SPEAKER

Press to turn the speakerphone on or off (page 15).



INCOMING CALL light

Flashes quickly when there is an incoming call.

MUTE light

On when the microphone is muted (page 17).

🔊SPEAKER light

On when the speakerphone is in use.

Installation

Make sure to install four AA alkaline batteries (not included).

A large black octagonal sign with a thick black border and the word "STOP!" in bold, black, sans-serif capital letters in the center.

See page 4 for easy instructions.

If you subscribe to high-speed Internet service (DSL - digital subscriber line) through your telephone line, you must install a DSL filter between the telephone line cord and the telephone wall jack (page 6). The filter prevents noise and caller ID problems caused by DSL interference. Please contact your DSL service provider for more information about DSL filters.

Your product may be shipped with a protective sticker covering the telephone base display - remove it before use.



CAUTION: To reduce the risk of fire or injury to persons or damage to the telephone, read and follow these instructions carefully:

- Use only alkaline AA batteries (not included).
- Dispose of these batteries in a safe manner. Do not burn or puncture. Like other batteries of this type, if burned or punctured, they could release caustic material which could cause injury.
- Do not open or mutilate the battery. Released electrolyte is corrosive and may cause damage to the eyes or skin. It may be toxic if swallowed.
- Exercise care in handling batteries in order not to create a short circuit. Do not allow conductive materials such as rings, bracelets or keys to touch the battery. The battery or conductor may overheat and cause harm.
- Use the battery identified for use with this product only in accordance with the instructions and limitations specified in this manual.
- Observe proper polarity orientation between the battery and metallic contacts.
- Do not disassemble your telephone. There are no serviceable parts inside. Refer to qualified service personnel for servicing.

Battery installation

Before using the telephone, you should install four new AA alkaline batteries (not included) to provide memory backup and enable the use of some features. The four AA batteries are required for the following features to work: speakerphone, mute, flash, caller ID, display, menu, directory, redial, speed dial, clock, Audio Assist® and the **INCOMING CALL** light.

If you unplug the telephone line cord from the telephone wall jack when there are no working batteries installed, the following information will be lost: caller ID history, directory entries, speed dial entries, and all settings in the feature menu. We recommend you install new batteries before initial use and change the batteries soon after the low battery icon  appears.

 **CAUTION:** Always unplug the telephone line cord before installing new batteries.

1. Press the large tabs on the battery compartment cover as the arrows indicated below to open the battery compartment cover.

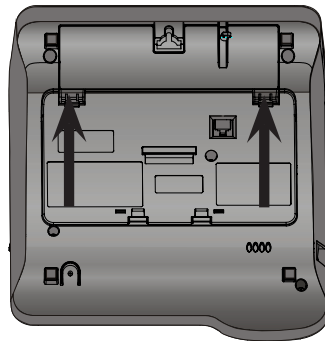

2. Detach the battery compartment cover from the telephone base.

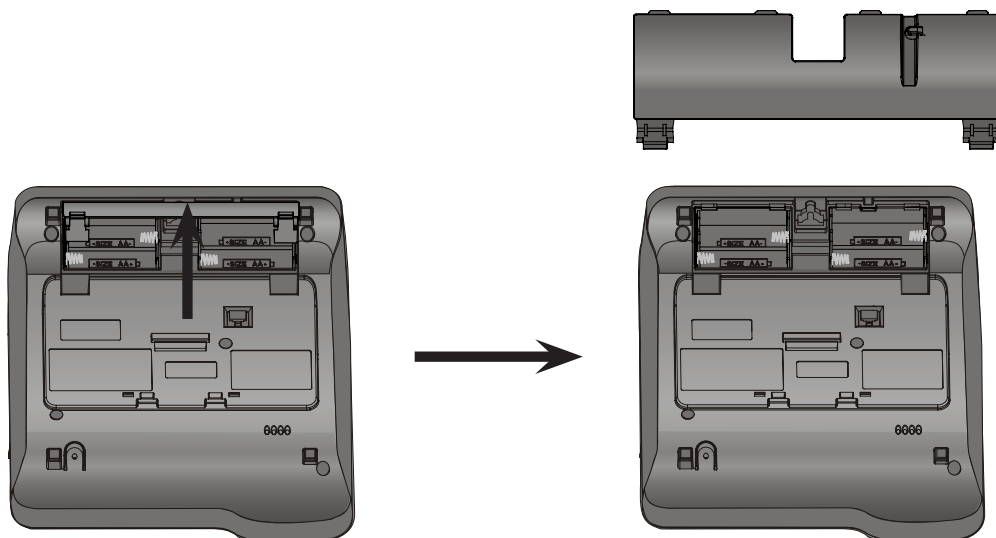

Battery installation

3. Insert four new AA alkaline batteries (not provided) into the battery compartment, following the polarity markings.

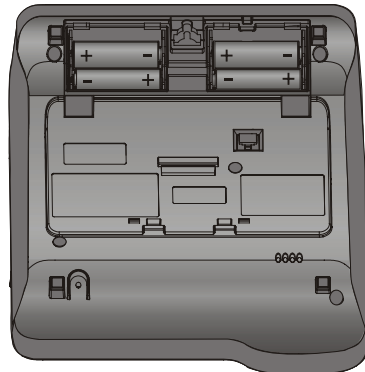

4. Insert the small tabs on the battery compartment cover into the slots on the battery compartment at the telephone base. Then press down on the battery compartment cover as the arrows indicated until it clicks into place.

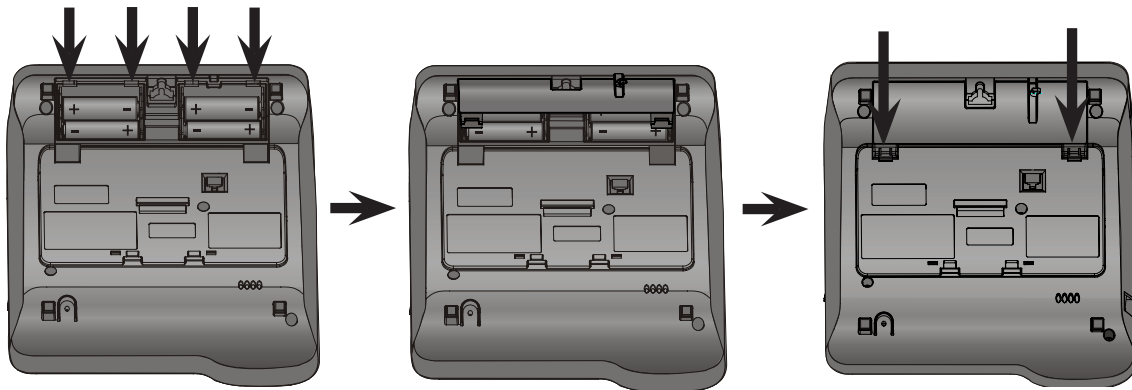

If no batteries are installed or the batteries are depleted, you can make or answer calls using only the handset.



NOTES:

- Use disposable AA alkaline batteries only. Do not use rechargeable batteries.
- If you do not use the telephone for a long time, remove the batteries from the telephone to prevent possible leakage.
- After replacing the batteries, you need to reset the date and time. For instructions, see **Set date and time** on page 11.
- If no batteries are installed, you can only make or answer calls using the handset, however, you can switch to the speakerphone mode during the call by pressing  **SPEAKER**.

Telephone installation

Install the telephone base as shown below. If you subscribe to high-speed Internet service (DSL - digital subscriber line) through your telephone line, you must install a DSL filter between the telephone line cord and the telephone wall jack. The filter prevents noise and caller ID problems caused by DSL interference. Please contact your DSL service provider for more information about DSL filters.

1. Plug one end of the coiled handset cord into the handset jack on the left side of the telephone base. Plug the other end into the jack at the bottom of the handset.

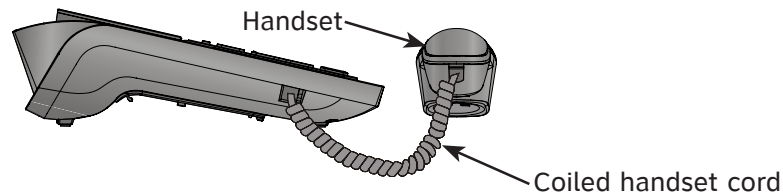

2. Plug one end of the telephone line cord into the **TEL LINE** jack on the back of the telephone base. Plug the other end of the telephone line cord into a telephone wall jack or a DSL filter.

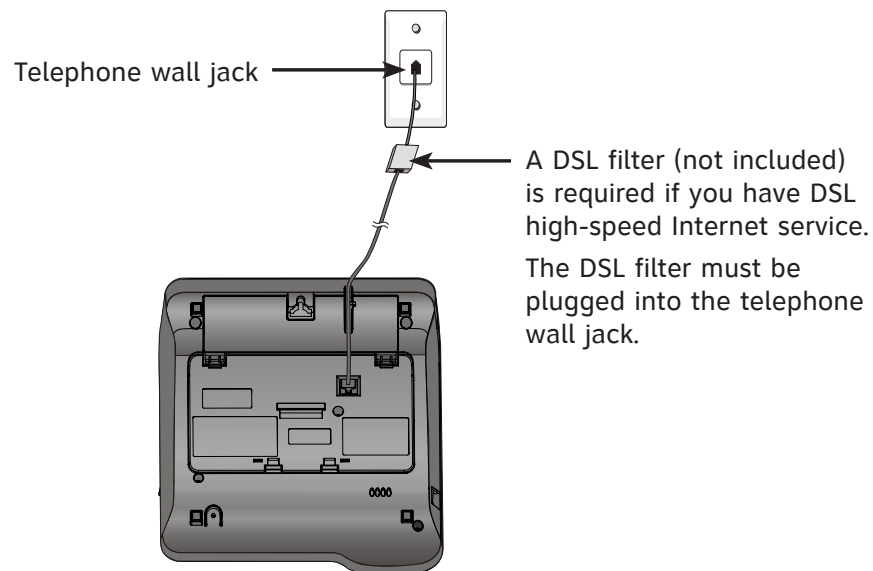

3. Lift the handset or press **SPEAKER** to check for a dial tone.
4. Adjust the angle of the tilt display to reach maximum visibility.

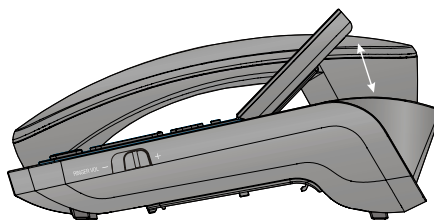

Installation options

If you want to mount your telephone on a wall, use the mounting bracket provided with the package to connect with a standard dual-stud telephone wall mounting plate. If you do not have this mounting plate, you can purchase one from many hardware or consumer electronic retailers. Professional assistance may be required to install the mounting plate.

Tabletop to wall mount installation

To install the telephone base in the wall mount position, make sure you first unplug the telephone line cord from the telephone wall jack.

1. Put the handset aside. Hold down the switch hook on the telephone base, then slide the handset tab upwards to remove it from the slot. Rotate the handset tab by 180 degrees. Then replace the handset tab into the slot until it locks into position.

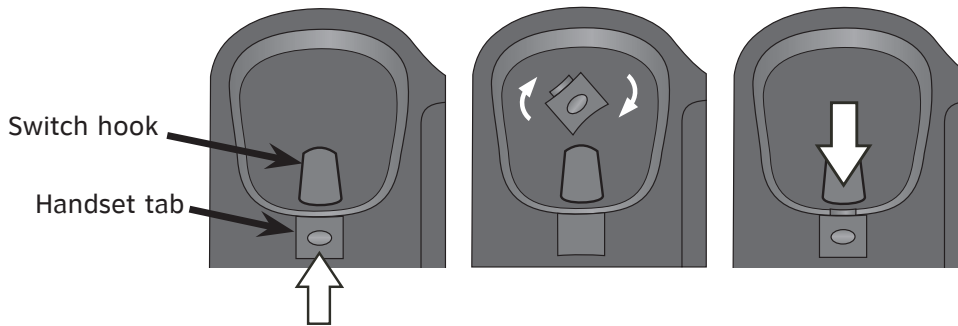

2. Insert the protruding tab of the mounting bracket into the groove at the center of the telephone base. Press down on the small tabs of the mounting bracket and snap them into the slots at the telephone base.

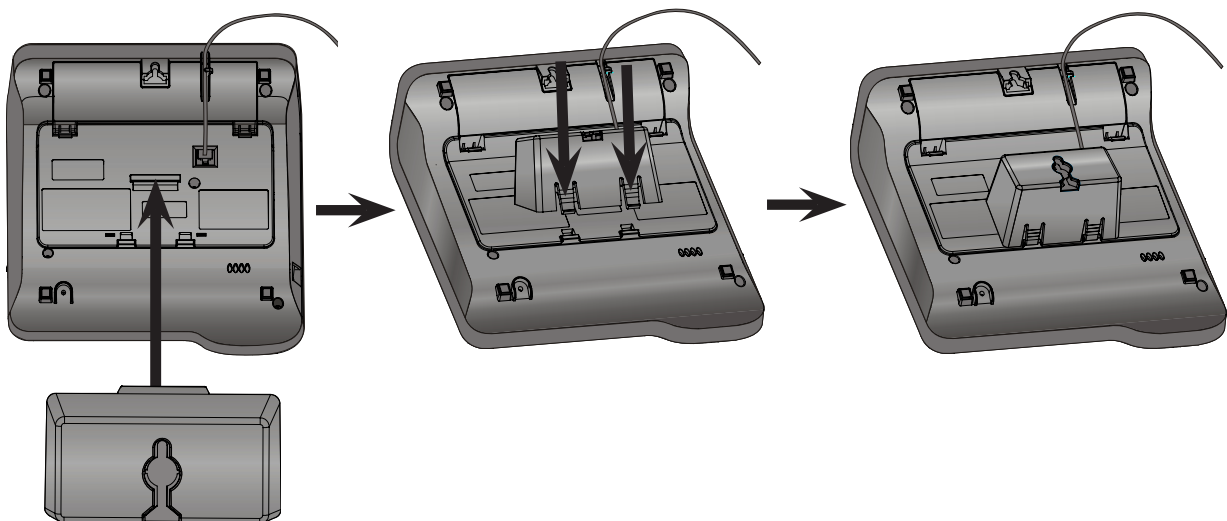

Installation options

3. Remove the telephone line cord from the slot on the bottom of the telephone base. Bundle the telephone line cord securely with a twist tie.

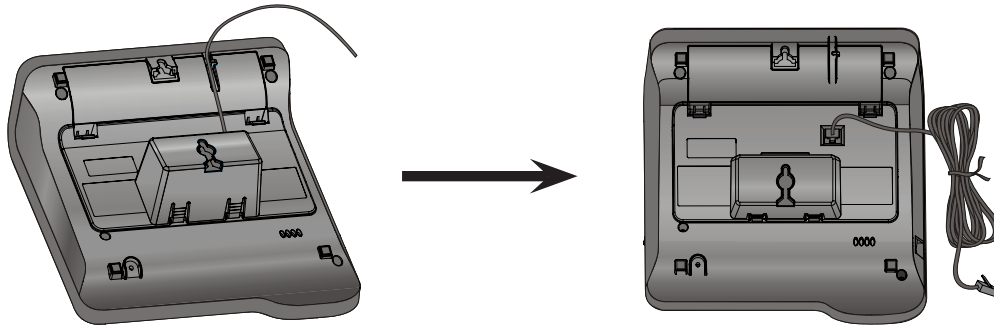

4. Plug the other end of the telephone line cord into a telephone wall jack or a DSL filter.

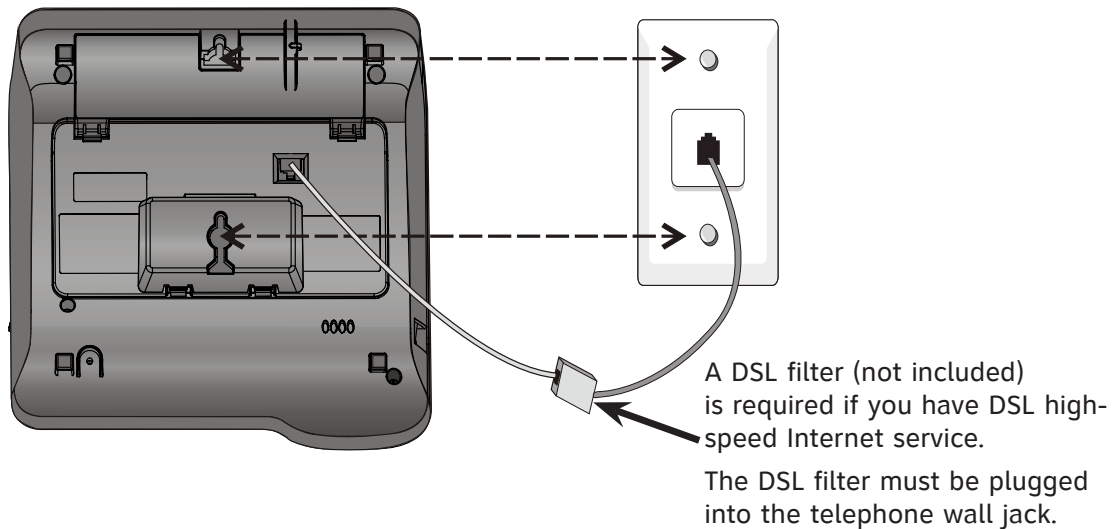

5. Align the holes on the bottom of the telephone base with the wall mounting plate. Then slide the telephone base down until it locks securely. Replace the handset in the telephone base.

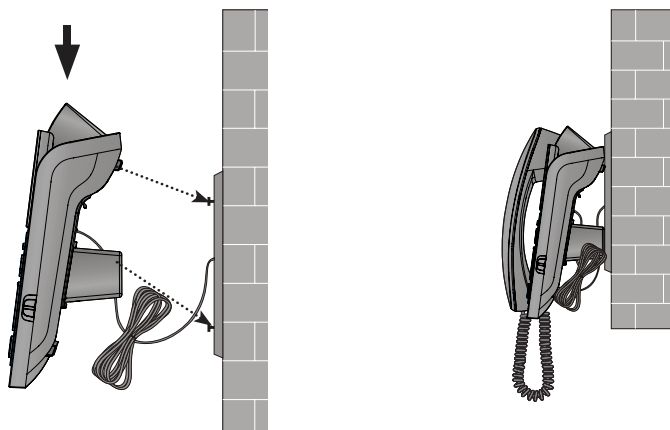

6. Adjust the viewing angle of the tilt display for maximum visibility.

Installation options

Wall mount to tabletop installation

To change the telephone base from the wall mount position to tabletop position, follow the steps below.

1. Slide the telephone base upwards, then remove it from the wall mounting plate.

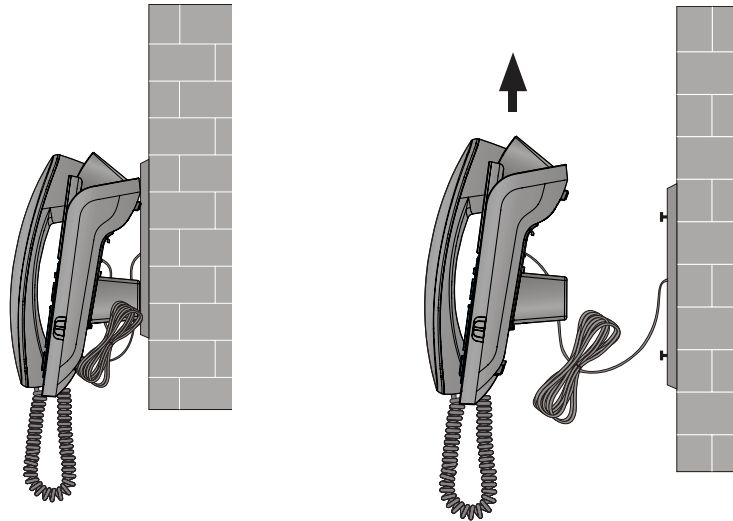

2. Unplug the telephone line cord from the telephone wall jack. Untie the bundled telephone line cord, if necessary. Route the telephone line cord through the slot on the bottom of the telephone base.

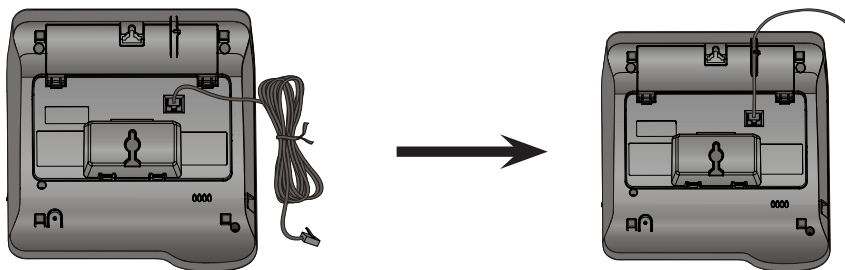

3. Put the handset aside. Hold down the switch hook on the telephone base, then slide the handset tab upwards to remove it from the slot. Rotate the handset tab by 180 degrees. Then replace the handset tab into the slot until it locks into position.

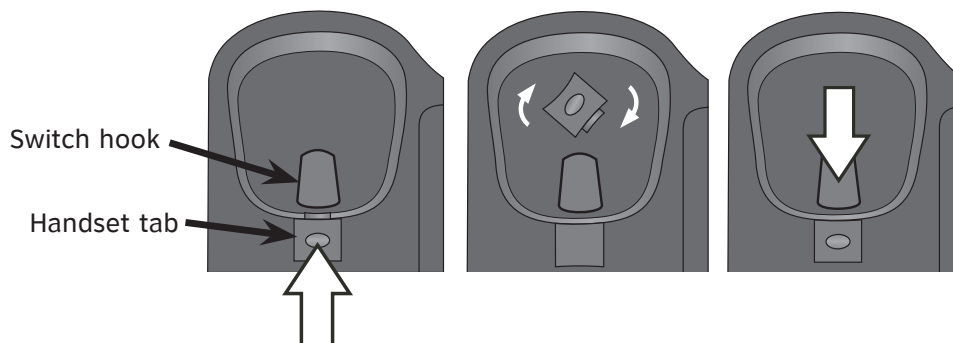

Installation options

4. Press on the small tabs of the mounting bracket and then pull the mounting bracket up to detach it from the telephone base.

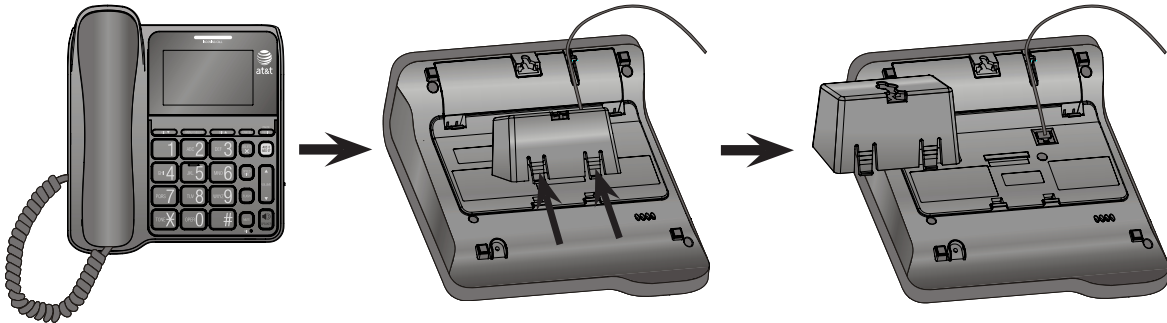

5. Plug the other end of the telephone line cord into a telephone wall jack or a DSL filter. Replace the handset in the telephone base.

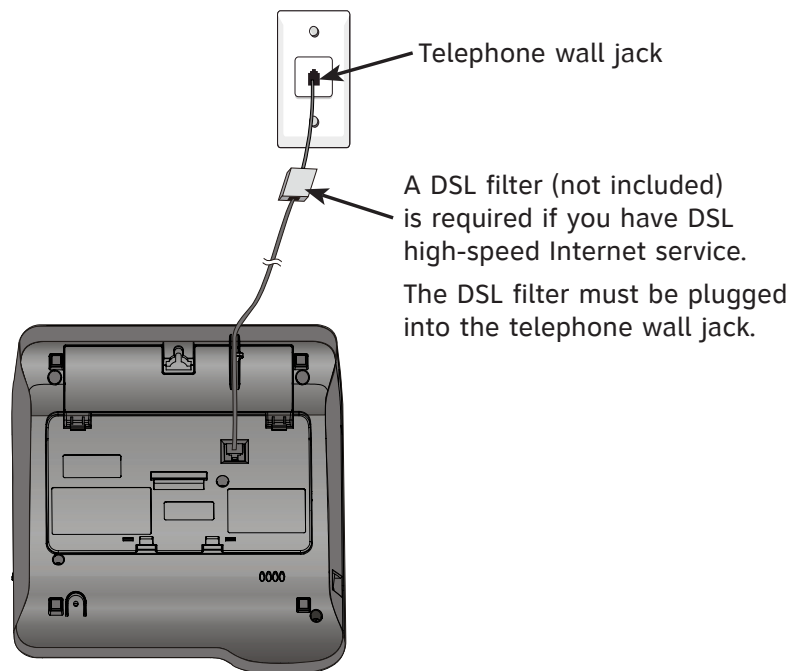

6. Adjust the viewing angle of the tilt display for maximum visibility.

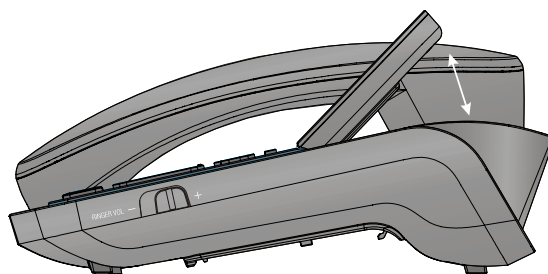

Telephone settings

Use the menu to change the telephone settings.

1. Press **MENU/SELECT** repeatedly until the screen displays the desired feature.
2. Press **CID**▼ or **DIR**▲ until the screen displays the desired setting.
3. Press **MENU/SELECT** to save your selection and move to the next feature.



NOTE: Press **CANCEL** to cancel an operation or exit the menu.

Set date and time

When the telephone is idle, the screen shows the date and time. If you subscribe to caller ID service, the day, month and the time are set automatically with each incoming call. You may also set the date and time manually by following the steps below.

1. Press **MENU/SELECT**, the screen displays **DATE/TIME** and **USE # FOR AM/PM** alternatively.
2. Use the dial pad keys (**0-9**) to set the month, or press **DIR**▲ to skip to set the day.
3. Use the dial pad keys (**0-9**) to set the day, or press **DIR**▲ to skip to set the hour.
4. Use the dial pad keys (**0-9**) to set the hour, or press **DIR**▲ to skip to set the minute.
5. Use the dial pad keys (**0-9**) to set the minute.
6. Press **#** (pound key) to select between **AM** or **PM**.
7. Press **MENU/SELECT** to save your setting and move to the next menu setup.

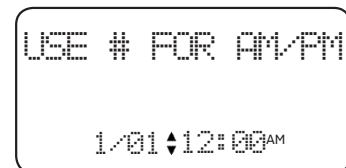
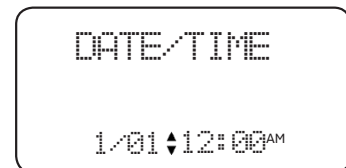

Telephone settings

Contrast

You can set the contrast of the screen to one of four levels.

1. Press **MENU/SELECT** repeatedly until the screen displays **CONTRAST**.
2. Press **CID▼** or **DIR▲** to choose from 1, 2 (default setting), 3 or 4.
3. Press **MENU/SELECT** to save your setting and move to the next menu setup.

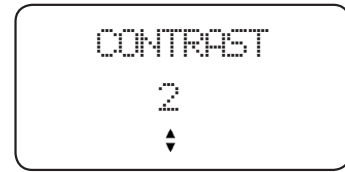

Dial mode

The dial mode is preset to touch-tone dialing. If you have pulse (rotary) service, you must change the dial mode to pulse dialing before using the telephone.

1. Press **MENU/SELECT** repeatedly until the screen displays **DIAL MODE**.
2. Press **CID▼** or **DIR▲** to choose **TOUCH TONE** (default setting) or **PULSE**.
3. Press **MENU/SELECT** to save your setting and move to the next menu setup.

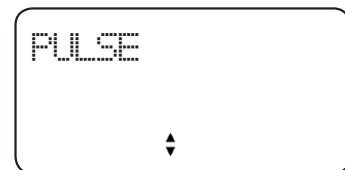
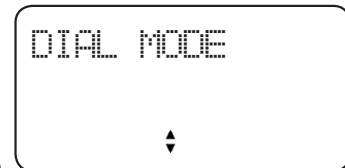

Telephone settings

Language

You can select the language used for all screen displays.

1. Press **MENU/SELECT** repeatedly until the screen displays **LANGUAGE**.
2. Press **CID**▼ or **DIR**▲ to choose **ENGLISH** (default setting), **ESPAÑOL** or **FRANCAIS**, then press **MENU/SELECT**. The screen displays **SET LANGUAGE?**.
3. Press **MENU/SELECT** to confirm your setting and move to the next feature setup.

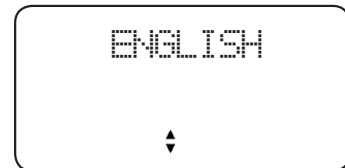

NOTE: If you accidentally change the language to French or Spanish, you can reset it back to English without going through the French or Spanish menus. When in idle mode, press **MENU/SELECT** once, then enter ***3645474#**.

Home area code

If you dial seven digits to make a local call (no area code required), enter your area code into the telephone as the home area code. When you receive a call from within your home area code, the caller ID history only displays the seven digits of the telephone number, and when you dial from the call log, only seven digits are dialed.

If you use 10-digit (area code + telephone number) or 11-digit (1 + area code + telephone number) formatting to dial within your area code, leave this setting blank.

1. Press **MENU/SELECT** repeatedly until the screen displays **HOME AREA CODE**.
2. Use the dial pad keys (**0-9**) to enter a three-digit home area code. To delete an entered digit, press **CID**▼ or **DIR**▲ to move to the desired location, then press **DELETE X**.
3. Press **MENU/SELECT** to save your setting and move to the next menu setup.



Telephone settings

Local area code

If you dial 10 digits to make calls to areas outside your home area code (without dialing 1), then set local area codes into the telephone. After setting, if you receive a call from one of these local area codes, the screen displays the 10 digits of the telephone number.

1. Press **MENU/SELECT** repeatedly until the screen displays **LOCAL AREA CODE**.
2. Use the dial pad keys (**0-9**) to enter the first local area code in **LAC 1**. To delete an entered digit, press **CID▼** or **DIR▲** to move to the desired location, then press **DELETE X**.
3. Press **MENU/SELECT** to save the first local area code setting and advance to the next local area code setting (**LAC 2**, **LAC 3** or **LAC 4**), then follow step 2 above to set other local area codes if necessary.
4. Press **MENU/SELECT** to save your setting and move to the next menu setup.



Telephone operation

Making a call

Lift the handset or press **◀▶SPEAKER**, then use the dialing keys to dial a number.

The screen displays the elapsed time as you talk (in hours, minutes and seconds).

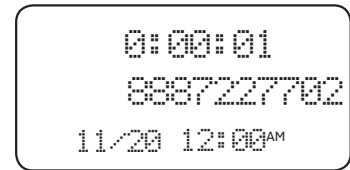

On hook dialing (predialing)

1. Enter the telephone number. Press **DELETE X** to make corrections when entering the telephone number.
2. Lift the handset or press **◀▶SPEAKER**.

Answering a call

Lift the handset or press **◀▶SPEAKER**.

Ending a call

Place the handset back in the telephone base, or press **◀▶SPEAKER** while using the speakerphone.

Speakerphone

To switch from the handset to the speakerphone during a call:

- Press **◀▶SPEAKER** then place the handset in the telephone base.

To switch from the speakerphone to the handset during a call:

- Lift the handset.

Telephone operation

Last number redial

The telephone stores the last number dialed (up to 24 digits).

To dial the last dialed number:

1. Lift the handset or press **SPEAKER**.
2. Press **REDIAL/PAUSE** to dial the number.

-OR-

1. When the telephone is idle, press **REDIAL/PAUSE** to display the last dialed number.
2. Lift the handset or press **SPEAKER** to dial the number.

To delete the last dialed number:

1. When the telephone is idle, press **REDIAL/PAUSE** to show the last dialed number.
2. Press **DELETE X**. The screen shows **DELETED** then returns to idle mode.

i **NOTE:** If there is no number in the redial memory when you press **REDIAL/PAUSE**, the screen shows **REDIAL EMPTY**.

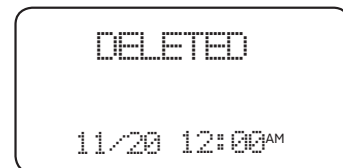
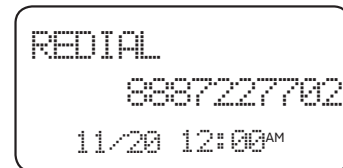
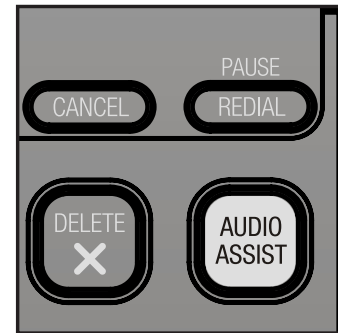

Ringer volume

Slide the **RINGER VOL -/+** switch at the right side of the telephone base to set the ringer volume level to off, low, middle or high. When the ringer volume is set to off,  appears on the screen.

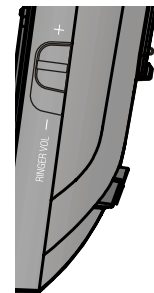

Options while on call

Volume control

You can set the listening volume to one of four levels. While on a call, press **▲VOLUME▼** to adjust the listening volume. The volume level indicator briefly displays on the screen to indicate the setting.

Handset volume

When you are on a call using the handset, press **▲VOLUME** to increase or **VOLUME▼** to decrease the handset listening volume.



Speakerphone volume

When you are on a call using the speakerphone, press **▲VOLUME** to increase or **VOLUME▼** to decrease the speakerphone volume.

Call waiting

If you subscribe to call waiting service from your telephone service provider, you hear a beep if someone calls you while you are already on a call.

- Press **FLASH** to put your current call on hold and take the new call.
- Press **FLASH** at any time to switch back and forth between calls.

Mute

Use the mute function to turn off the microphone. You can hear the caller, but the caller cannot hear you.

To mute the call:

- During a call, press **MUTE** to mute the microphone. The **MUTE** light turns on.

To end mute a call:

- Press **MUTE** again to resume the conversation. The **MUTE** light turns off.



NOTE: Switching between the handset and the speakerphone cancels the mute function.

Options while on call

Chain dialing

Use this feature to initiate a dialing sequence from the numbers in the directory, speed dial memory or caller ID history while you are on a call.

Chain dialing is useful if you need to access numbers other than telephone numbers (such as bank account numbers or access codes) from the directory, speed dial memory locations or call log.

To access the directory while on a call:

1. Press **DIR▲** to enter the directory.
2. Press **CID▼** or **DIR▲** until **REVIEW** is blinking.
Press **MENU/SELECT** to show the first entry in the directory.
3. Press **CID▼** or **DIR▲** to scroll to the desired entry, or press the dialing keys (**0-9**) to start a name search (see **Search by name** on page 22).
4. Press **MENU/SELECT** to dial the displayed number.

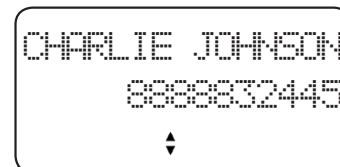

To access the speed dial memory while on a call:

1. Press **SPEED DIAL**. The screen shows **ENTER SPDIAL #**.
2. Use the dialing keys (**0-9**) to enter the desired speed dial location. The telephone dials the displayed number.

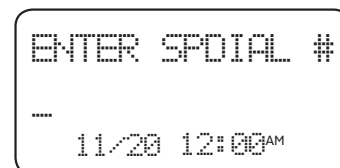

To access the caller ID history while on a call:

1. Press **CID▼** to enter the caller ID history.
2. Press **CID▼** or **DIR▲** to scroll to the desired entry.
3. Press **MENU/SELECT** to dial the displayed number.

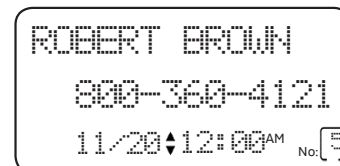

Options while on calls

Audio Assist®

The Audio Assist® feature makes voices sound louder and clearer.

To turn the Audio Assist® feature on:

Press **AUDIO ASSIST** while you are on a call using the handset, the **AUDIO ASSIST** icon displays on the screen.



To turn the Audio Assist® feature off:

Press **AUDIO ASSIST** again, the **AUDIO ASSIST** icon turns off. This feature is also turned off automatically after you hang up.

Temporary tone dialing

If you have pulse (rotary) dialing service only, you can switch from pulse to touch-tone dialing temporarily during a call. This is useful if you need to send touch-tone signals to access your telephone banking or long distance services.

1. During a call, press **TONEX**.
2. Use the dialing keys to enter the desired number. The telephone sends touch-tone signals.
3. The telephone automatically returns to pulse dialing mode after you end the call.

Directory

Directory memory capacity

The directory can store up to 25 entries, with a maximum of 15 alphanumeric characters for names and 24 digits for telephone numbers.

Directory entries are stored in alphabetical order, according to the first character. You may wish to enter names with the last name first to maintain consistency with information stored through the caller ID features of this telephone.

Press **CANCEL** while reviewing the directory or entering/editing entry to exit the directory without saving changes.

Character chart

Refer to the chart below and use the dial pad keys to enter the letters, digits or symbols. Press the key repeatedly until the desired character shows on the screen.

Dial Key	Characters by number of key press							
	1	2	3	4	5	6	7	8
1	1	.	,	-	/	&		
2	A	B	C	2				
3	D	E	F	3				
4	G	H	I	4				
5	J	K	L	5				
6	M	N	O	6				
7	P	Q	R	S	7			
8	T	U	V	8				
9	W	X	Y	Z	9			
0	0							
*	*							
#	#							

Create directory entries

Store a directory entry

Follow the steps below to store a new entry in the directory.

1. When the telephone is idle, press **DIR▲** to enter the directory menu.

2. Press **CID▼** or **DIR▲** until **STORE** is blinking.

3. Press **MENU/SELECT**.

4. When the screen displays **ENTER NUMBER**, use the dialing keys to enter a telephone number (up to 24 digits).

- Press **DELETE X** to erase a digit.
- Press **CID▼** or **DIR▲** to move the cursor to the left or right.
- Press **REDIAL/PAUSE** to insert a three-second dialing pause (a **P** appears).

-OR-

Press and hold **REDIAL/PAUSE** to copy the last number dialed.

5. Press **MENU/SELECT**.

6. When the screen displays **ENTER NAME**, use the dialing keys to enter a name (up to 15 characters). Additional key presses produce other characters on that key (see the **Character chart** on page 20).

- Press **DELETE X** to erase a character.
- Press **CID▼** or **DIR▲** to move the cursor to the left or right.

7. Press **MENU/SELECT** to save. Then the screen displays **STORED** then returns to directory menu.

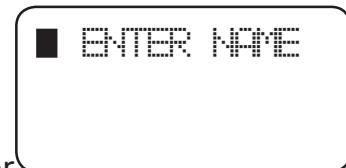
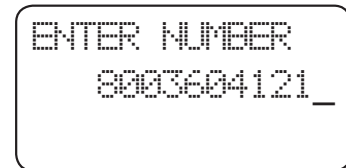
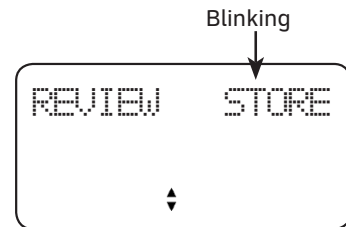

NOTES:

- If you enter more than 24 digits in a telephone number in step 4 above, the screen shows **ONLY 24 ALLOWED**.
- If you enter more than 15 characters in a name in step 6, the screen shows **ONLY 15 ALLOWED**.
- If you try to store more than 25 entries in the directory, the screen displays **MEMORY FULL**. You must delete an existing directory entry before you can store a new one.

Review the directory

Review directory entries

1. When the telephone is idle, press **DIR▲** to enter directory menu.
2. Press **CID▼** or **DIR▲** until **REVIEW** is blinking.
3. Press **MENU/SELECT** to display the first directory entry.
4. Press **CID▼** or **DIR▲** to browse through the directory.
Entries appear alphabetically by the first letter in the name.



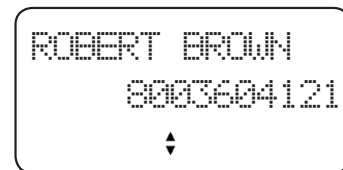

NOTES:

- If you try to view directory entries when there is none, the screen shows **DIRECTORY EMPTY**.
- The screen can show up to 12 digits in a row. If a telephone number in the directory exceeds 12 digits, the screen shows the first 12 digits and the rest of the digits alternatively.

Search by name

1. When the telephone is idle, press **DIR▲** to enter directory menu.
2. Press **CID▼** or **DIR▲** until **REVIEW** is blinking.
3. Press **MENU/SELECT** to display the first directory entry.
4. When an entry appears, press the dialing keys (**0-9**) to start a name search. The directory shows the first name beginning with the first letter associated with the dialing key if there is an entry in the directory beginning with that letter. Press **CID▼** or **DIR▲** to scroll through the directory.
5. To see other names starting with the letters on the same dialing key, keep pressing the key. The names appear in alphabetical order based on the first letter in the name.

For example, if you have the names **Jennifer**, **Jessie**, **Kevin** and **Linda** in your directory:

- If you press **5 (JKL)** once, you see **Jennifer**. Press **CID▼** and you see **Jessie**.
- If you press **5 (JKL)** twice, you see **Kevin**.
- If you press **5 (JKL)** three times, you see **Linda**.
- If you press **5 (JKL)** four times, you see **Jennifer** again.



NOTES:

- If there is no name matching the first letter of the key you press, the directory shows a name matching the following letters of the key.
- If there is no entry beginning with the associated letters, the screen displays **NO NAME FOUND**.

Dial or edit directory entries

Dial a directory number

1. Search for the desired directory entry (see **Review directory entries** on page 22).
2. When the desired entry displays, lift the handset or press **SPEAKER** to dial.

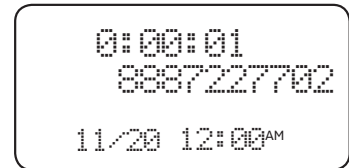

Edit a directory entry

1. Search for the desired directory entry (see **Review directory entries** on page 22).
2. Press **MENU/SELECT**. If you do not want to modify the name, skip to step 4.
3. The screen prompts you to edit the name.
 - Use the dialing keys to add characters (refer to the **Character chart** on page 20).
 - Press **DELETE X** to erase a character.
 - Press **CID▼** or **DIR▲** to move the cursor to the left or right.
4. Press **MENU/SELECT**.
5. The screen shows **ENTER NUMBER**.
 - Use the dialing keys to add digits.
 - Press **DELETE X** to erase a digit.
 - Press **CID▼** or **DIR▲** to move the cursor to the left or right.
 - Press **REDIAL/PAUSE** to insert a three-second dialing pause (a **P** appears).
6. Press **MENU/SELECT** to save the entry. The screen shows the edited directory entry.

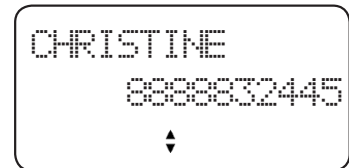
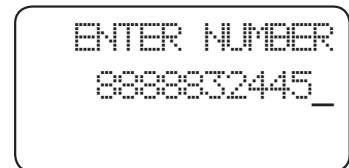
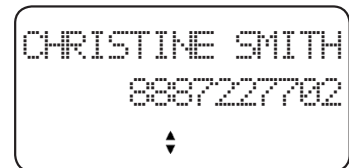

Delete directory entries

Delete a directory entry

1. Search for the desired directory entry (see **Review directory entries** on page 22).
2. Press **DELETE X** to delete the displayed entry. The screen then displays **DELETE ENTRY?**
3. Press **MENU/SELECT** to confirm. The screen then displays **DELETED**. You cannot retrieve a deleted entry.

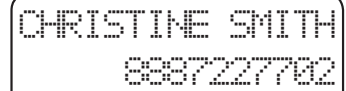

CHRISTINE SMITH
8887227702



DELETE ENTRY ?



DELETED

Speed dial

Speed dial memory overview

This telephone has 10 speed dial memory locations where you can store telephone numbers you wish to dial more quickly.

Each speed dial memory location can store a telephone number with up to 24 digits.

Store a speed dial entry

1. Press **SPEED DIAL** when the telephone is idle, the screen shows **SPEED DIAL #1**.

2. Press **CID**▼ or **DIR**▲ to choose an empty speed dial location (**0-9**). Or use the dialing keys (**0-9**) to select the desired speed dial location (**0-9**).

3. Press **MENU/SELECT**.

4. When the screen displays **ENTER NUMBER**, use the dialing keys to enter a telephone number (up to 24 digits).

- Press **DELETE X** to erase a digit.
- Press **CID**▼ or **DIR**▲ to move the cursor to the left or right.
- Press **REDIAL/PAUSE** to insert a three-second dialing pause (a **P** appears).

-OR-

Copy the number from the redial memory by pressing **REDIAL/PAUSE**.

5. Press **MENU/SELECT**. The screen shows **STORED** and then the speed dial number stored.



NOTE: If you enter more than 24 digits in a telephone number in step 4, the screen shows **ONLY 24 ALLOWED**.

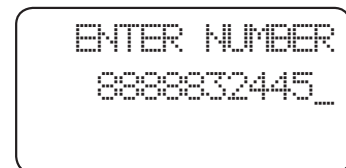
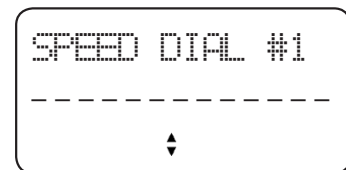

Speed dial

To review a speed dial number

1. Press **SPEED DIAL** when the telephone is idle.
2. Press **CID**▼ or **DIR**▲ to choose the desired speed dial memory location (**0-9**).

-OR-

Press the dialing key (**0-9**) to choose the desired speed dial memory location. The screen shows the telephone number stored in that memory location.



```
SPEED DIAL #1
8887227702
♦
```

i **NOTE:** The screen can show up to 12 digits in a row. If a telephone number in the speed dial location exceeds 12 digits, the screen shows the first 12 digits and the rest of the digits alternatively.

To dial a speed dial number

1. Lift the handset or press **◀▶SPEAKER**.
2. Press **SPEED DIAL**. The screen displays **ENTER SPDIAL #**.
3. Use the dialing key (**0-9**) to enter the desired speed dial location. The telephone dials the corresponding speed dial number.



```
ENTER SPDIAL#
...
11/20 12:00AM
```

-OR-

1. Press **SPEED DIAL** when the telephone is idle.
2. Press **CID**▼ or **DIR**▲ to choose the desired speed dial memory location (**0-9**).

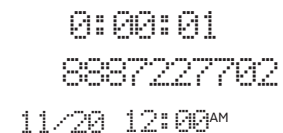

```
0:00:01
8887227702
11/20 12:00AM
```

-OR-

Use the dialing keys (**0-9**) to enter the desired speed dial location.

3. When the screen displays the desired entry, lift the handset or press **◀▶SPEAKER**. The telephone dials the displayed number.

Speed dial

To edit a speed dial number

1. See **To review a speed dial number** on page 26 to show the desired speed dial entry.
2. Press **MENU/SELECT**.
3. The screen shows **EDIT NUMBER** and the telephone number.
 - Use the dialing keys to add digits.
 - Press **DELETE X** to erase a digit.
 - Press **REDIAL/PAUSE** to insert a three-second dialing pause (a **P** appears).
4. Press **MENU/SELECT**. The screen shows **STORED** then the edited speed dial number.



SPEED DIAL #1
8887227702
⬆

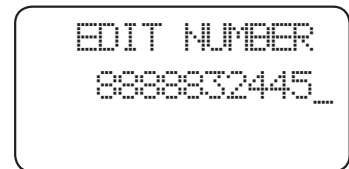

EDIT NUMBER
8888832445_



STORED



SPEED DIAL #1
8888832445
⬆

To delete a speed dial number

1. See **To review a speed dial number** on page 26 to show the desired speed dial entry.
2. Press **DELETE X**. The screen shows **CLEAR SPDIAL?**
3. Press **MENU/SELECT** to confirm. The screen then displays **DELETED**. You cannot retrieve a deleted entry.

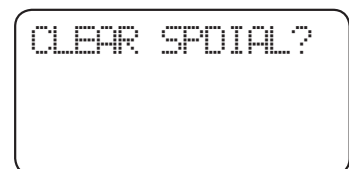

CLEAR SPDIAL?

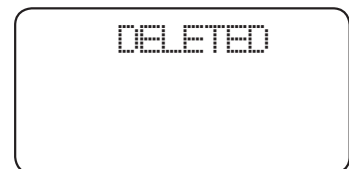

DELETED

About caller ID

This product supports caller ID services offered by most telephone service providers. Caller ID allows you to see the name, number, date and time of calls. The available caller ID information will appear after the first or second ring.

Information about caller ID with call waiting

Caller ID with call waiting lets you see the name and telephone number of the caller before answering the call, even while on another call.

It may be necessary to change your telephone service to use this feature. Contact your telephone service provider if:

- You have both caller ID and call waiting, but as separate services (you may need to combine these services).
- You have only caller ID service, or only call waiting service.
- You don't subscribe to caller ID or call waiting services.

There are fees for caller ID services. In addition, services may not be available in all areas.

This product can provide information only if both you and the caller are in areas offering caller ID service and if both telephone service providers use compatible equipment. The time and date, along with the call information, are from the telephone service provider.

Caller ID information may not be available for every incoming call. Callers may intentionally block their names and/or telephone numbers.



NOTE: You can use this product with regular caller ID service, or you can use this product's other features without subscribing to caller ID or combined caller ID with call waiting service.

Caller ID history

How the caller ID history (caller ID log) works

The telephone stores caller ID information about the last 65 incoming calls. Entries are stored in reverse chronological order. The phone deletes the oldest entry when the log is full to make room for new calls. If you answer a call before the information appears on the screen, it does not show in the caller ID history.

Missed (new) call indicator

When the telephone is in idle mode and has new or missed calls, its screen shows **XX MISSED CALLS**.

All new and missed entries are counted as missed calls. Each time you review a new caller ID log entry (indicated by the **NEW** icon on the screen), the number of missed calls decreases by one.

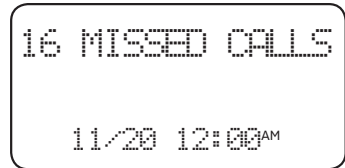

When the telephone is in idle mode, you can press and hold **CANCEL** to clear the missed call indicator.

Caller ID operation

Memory match

If the incoming telephone number matches the last seven digits of a telephone number in your directory, the name that appears on the screen matches the corresponding name in your directory.

For example, if Christine Smith calls, her name appears as **CHRIS** if this is how you entered it into your directory.



NOTE: The number shown in the caller ID log will be in the format sent by the telephone service provider. The telephone service provider usually delivers 10-digit phone numbers (area code plus telephone number). If the telephone number of the caller does not match a number in your directory, the name will appear as it is delivered by the telephone service provider.



Caller ID operation

Review the caller ID history

Review the caller ID history to find out who called, to return the call, or to copy the caller's name and number into your directory. **CALL LOG EMPTY** appears if there are no records in the caller ID history.

1. When the telephone is in idle mode, press **CID** ▼ to review the caller ID history in reverse chronological order starting with the most recent call.
2. Press **CID** ▼ or **DIR** ▲ to scroll through the entries.
3. Press **CANCEL** to exit the caller ID history.

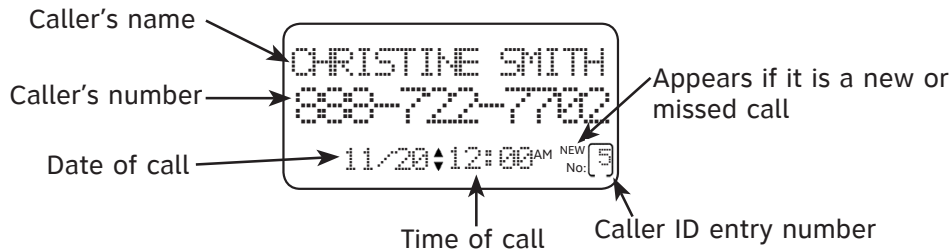
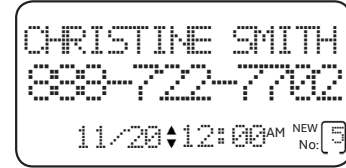

View dialing options

Although the incoming caller ID log entries have 10 digits (the area code plus the seven-digits number), in some areas, you may need to dial only the seven digits, 1 plus the seven digits, or 1 plus the area code plus the seven digits. You can change and store the number of digits that you dial in the caller ID history.

While reviewing a caller ID history entry, press **#** (pound key) repeatedly to show different dialing options for local and long distance numbers before dialing or saving the telephone number in the directory or speed dial memory.

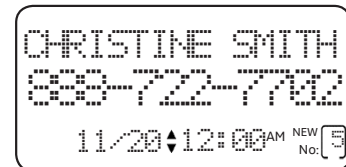

When the number is in the correct format for dialing, lift the handset or press **SPEAKER** to call the number.

To save the number to the directory or speed dial memory, see **Save a caller ID log entry to the**

directory on page 33 or **Save a caller ID log entry to a speed dial memory location** on page 34.

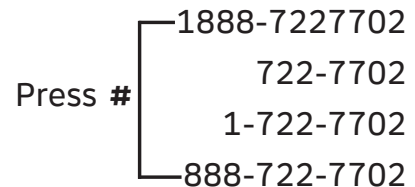

Caller ID operation

Dial a caller ID log entry

1. Press **CID**▼ to enter the caller ID history when the telephone is idle.
2. Press **CID**▼ or **DIR**▲ to scroll to the desired entry.
3. Lift the handset or press **SPEAKER** to dial the displayed number.

Delete call ID log entries

To delete an entry:

1. When the telephone is idle, press **CID**▼ to enter the caller ID history.
2. Press **CID**▼ or **DIR**▲ to scroll to the desired entry.
3. Press **DELETE X**, the screen displays **DELETE ENTRY ?**
4. Press **MENU/SELECT** to delete the displayed entry. The screen displays **DELETED** then the next caller ID history entry (if any).

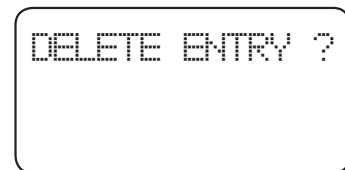
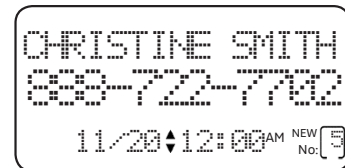

To delete all entries:

1. When the telephone is idle, press and hold **DELETE X**. The screen displays **CLEAR CALL LOG?**
2. Press **MENU/SELECT** within three seconds to confirm. The screen displays **DELETED** and then returns to idle mode.

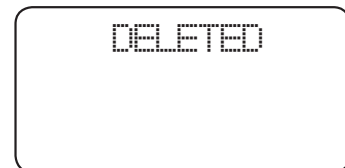
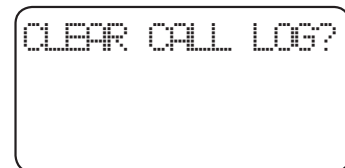

Caller ID operation

Save a caller ID log entry to the directory

1. Press **CID**▼ to enter the caller ID history when the telephone is idle.
2. Press **CID**▼ or **DIR**▲ to scroll to the desired entry.
3. Press **MENU/SELECT**. Use the dialing keys to edit the name, if necessary.
 - Press **DELETE X** to erase a character.
 - Press **CID**▼ or **DIR**▲ to move the cursor to the left or right.
4. Press **MENU/SELECT**. Then the screen displays **SAVE TO DIR**.

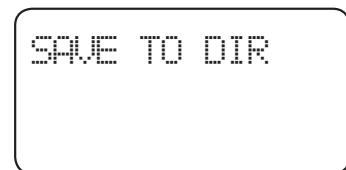
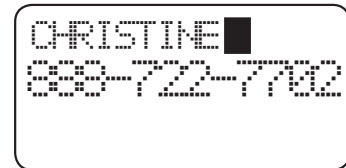
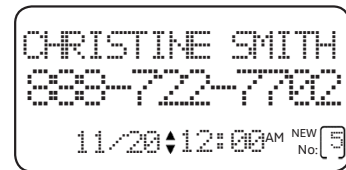

NOTES:

- You may need to change how a caller ID number is dialed if the entry does not appear in the correct format. Caller ID numbers may appear with an area code that may not be necessary for local calls, or without a 1 that may be necessary for long distance calls (see **View dialing options** on page 31).
- If there is no name in the caller ID history when you press **MENU/SELECT** in step 3 above, the screen shows **ENTER NAME**. Enter the name using the dialing keys and then press **MENU/SELECT** to confirm. The screen shows **SAVED TO DIR** then the telephone returns to caller ID review mode.

Caller ID operation

Save a caller ID log entry to a speed dial memory location

1. When the telephone is idle, press **CID**▼ to enter the caller ID history.
2. Press **CID**▼ or **DIR**▲ to scroll to the desired entry.
3. Press **SPEED DIAL**. The screen shows **ASSIGN SPDIAL #**.
4. Press a dial pad key (**0-9**) to choose the desired speed dial memory location. The screen shows **STORED** to confirm.

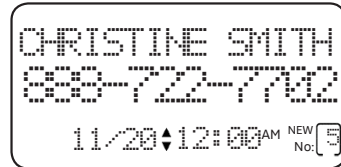

CHRISTINE SMITH
888-722-7702
11/20 12:00 AM NEW No. 5



ASSIGN SPDIAL #
.....

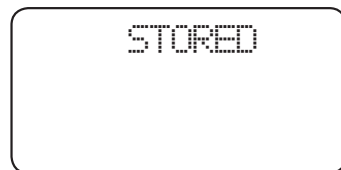

STORED



NOTES:

- You may need to change how a caller ID number is dialed if the entry does not appear in the correct format. Caller ID numbers may appear with an area code that may not be necessary for local calls, or without a 1 that may be necessary for long distance calls (see **View dialing options** on page 31).
- If the speed dial memory location you select in step 4 above is occupied, the screen shows **OVERWRITE?**. If you press **MENU/SELECT**, the new telephone number replaces the old one and the screen shows **STORED** to confirm.



Reasons for missing caller ID information

There are occasions when other information or no information shows for various reasons:

On-screen message	Reason
PRIVATE NUMBER	The caller prefers not to show the phone number.
PRIVATE NAME	The caller prefers not to show the name.
PRIVATE CALLER	The caller prefers not to show the phone number and name.
UNKNOWN NUMBER	Your telephone service provider cannot determine the caller's number.
UNKNOWN NAME	Your telephone service provider cannot determine the caller's name.
UNKNOWN CALLER	Your telephone service provider cannot determine the caller's name and telephone number. Calls from other countries may also generate this message.

Screen messages and icons

Screen icons

NEW	New caller ID log - new and missed calls.
No: [5]	Caller ID entry counter - caller ID entry number.
	Ringer off - the ringer is off.
	Low battery indicator - the power of the installed batteries is low.
AUDIO ASSIST	Audio Assist [®] - the Audio Assist [®] feature is turned on.

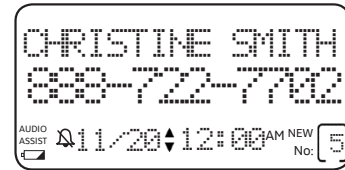

Screen messages and icons

Screen display messages

CALL LOG EMPTY	There are no caller ID history entries.
CHECK BATTERY	There is no battery installed or the installed batteries are depleted.
DELETED	All caller ID history entries have been deleted. -OR- A caller ID history entry, directory entry, speed dial entry or redial number has been deleted.
DIRECTORY EMPTY	There are no directory entries.
END OF LIST	You have reached the end of the caller ID history.
IN USE/NO LINE	Another telephone on the same line is in use. There is no telephone line connected to the telephone.
INCOMING CALL	There is an incoming call.
LOW BATTERY	The battery is low. You should change the batteries.
MEMORY FULL	The directory is full.
NO NAME FOUND	There are no entries in the directory matching the key pressed.
ONLY 15 ALLOWED	You have entered over 15 characters in the name of a directory entry.
ONLY 24 ALLOWED	You have entered over 24 digits in the number of a directory entry or speed dial entry.
STORED	The entry is saved in the directory or speed dial memory location successfully.
REDIAL EMPTY	There is no redial record.
XX MISSED CALLS	There are new calls in the caller ID log.

Troubleshooting

If you have difficulty with your telephone, please try the suggestions below. For customer service, or to purchase accessories or replacement parts, visit our website at **www.telephones.att.com** or call **1 (800) 222-3111**. In Canada, dial **1 (866) 288-4268**.

My telephone does not work at all.

- Unplug the batteries and telephone line cord. Wait for approximately 15 seconds, then plug them in again. Allow up to one minute for the telephone to synchronize.

There is no dial tone.

- Try the suggestion above.
- The telephone line cord may be defective. Try installing a new telephone line cord.
- Make sure the coiled handset cord is securely installed between the handset and the telephone base.
- Disconnect the telephone base from the telephone jack and connect a different telephone. If there is no dial tone on that telephone either, the problem is in your wiring or telephone service. Contact your telephone service provider (charges may apply).

I cannot dial out.

- Try all suggestions above.
- Make sure there is a dial tone before dialing. It is normal if the telephone takes a second or two before producing a dial tone. Wait an extra second before dialing.
- Check that all the telephones connected to the same telephone line are hung up.
- Make sure to set the **DIAL MODE** to the correct setting (touch-tone dialing or pulse dialing) for the service in your area (see **Dial mode** on page 12).
- If any of your other telephones are having the same problem, the problem is in the wiring or telephone service. Contact your telephone service provider (charges may apply).
- If you are using the speakerphone, eliminate any background noise. Noise from a television, radio, or other appliances might cause the telephone to not dial out properly. If you cannot eliminate the background noise, first try muting the telephone before dialing, or dialing from another room in your home with less background noise.

Troubleshooting

The telephone does not ring when there is an incoming call.

- Make sure the ringer is on (see page 16).
- Make sure the telephone line cord is plugged in properly (see **Telephone installation** on page 6).
- There may be too many extension telephones on the telephone line to allow all of them to ring simultaneously. Try unplugging one telephone at a time until the telephones start ringing.
- Test a working telephone at the same telephone jack. If another telephone has the same problem, the problem is in the telephone jack. Contact your telephone service provider (charges may apply).
- The telephone line cord may be defective. Try installing a new telephone line cord.

My calls fade out or cut in and out when I am using the telephone.

- If you are using the handset when this problem occurs, try unplugging the coiled handset cord and firmly plugging it in the handset and telephone base again.
- If you are using the speakerphone when this problem occurs, eliminate any background noise. Noise from the television, radio, or other appliances may cause the speakerphone to cut in and out. Try pressing **MUTE** when you are not speaking to eliminate the background noise.
- Disconnect the telephone base from the telephone wall jack and plug in another corded telephone. If calls are still not clear, the problem is probably in the wiring or telephone service. Contact your telephone service provider (charges may apply).
- If you subscribe to high-speed Internet service (DSL - digital subscriber line) through your telephone line, you must install a DSL filter between the telephone line cord and the telephone wall jack (see **Telephone installation** on page 6). The filter prevents noise and caller ID problems caused by DSL interference. Please contact your DSL service provider for more information about DSL filters.

I hear other calls when using the telephone.

- Disconnect the telephone base from the telephone wall jack. Plug in a different telephone. If you still hear other calls, the problem is probably in the wiring or telephone service. Contact your telephone service provider (charges may apply).

appears on the screen.

- The batteries need to be replaced. Replace four new alkaline AA batteries.

Troubleshooting

Display screen is blank.

- Make sure you have properly installed four working alkaline batteries (See **Battery installation** on pages 4-5).

Operation during a power failure.

- This telephone operates during a power failure if a telephone line cord is plugged between the telephone wall jack and the telephone base. You are able to answer calls with the handset, and make calls using the dialing keys. No other features work unless batteries are installed. All settings in menu options are retained during a power failure if a telephone line cord is plugged between the telephone wall jack and the telephone base.
- If you neither install batteries nor a telephone line, after a few minutes, the telephone clears the directory, caller ID history, speed dial memory, and the last number dialed memory. At the same time, all settings in menu options change back to their default settings.

My caller ID features are not working properly.

- Caller ID is a subscription service. You must subscribe to this service from your telephone service provider for this feature to work on your telephone.
- The caller may not be calling from an area that supports caller ID.
- Both your and the caller's telephone service providers must use equipment compatible with caller ID service.
- If you subscribe to high-speed Internet service (DSL - digital subscriber line) through your telephone line, you must install a DSL filter between the telephone line cord and the telephone wall jack (see **Telephone installation** on page 6). The filter prevents noise and caller ID problems caused by DSL interference. Please contact your DSL service provider for more information about DSL filters.
- Make sure the area codes are set correctly (see **Home area code** on page 13 and **Local area code** on page 14).
- Reset the telephone. See **Common cure for electronic equipment** on page 41.

The telephone does not receive caller ID or the telephone does not display caller ID during call waiting.

- Make sure you subscribe to caller ID with call waiting features provided by the telephone service provider.

Troubleshooting

- The caller might not be calling from an area that supports caller ID.
- Both your and the caller's telephone service providers must use equipment compatible with caller ID service.

I've set my LCD language to Spanish or French and I don't know how to change it back to English.

- When the telephone is in idle mode, press **MENU/SELECT** once, then enter ***3645474#**.

I subscribe to a nontraditional telephone service that uses my computer to establish connections, and my telephone doesn't work.

- Make sure your computer is powered on.
- Make sure your Internet connection is working properly.
- Make sure that the software is installed and running for your nontraditional telephone service.
- Make sure to plug your USB telephone adapter into a dedicated USB port on your computer. Do not plug into a multiple port USB hub (USB splitter) that is not powered.
- In a few rare instances, the USB port on your computer may not have enough power. In these instances, try using a USB hub with its own external power supply.
- If you are using a firewall, it may prevent access to your nontraditional telephone service provider. Contact your service provider for more information.

Common cure for electronic equipment:

If the telephone is not responding normally, try resetting the telephone. Do the following in the order listed:

1. Disconnect the telephone line cord from the telephone base.
2. Remove the batteries.
3. Wait a few minutes before connecting the telephone line cord to the telephone base.
4. Place the batteries back.
5. Wait for the telephone to synchronize its connection. This might take up to one minute.

General product care

To keep your telephone working well and looking good, follow these guidelines:

- Avoid putting it near heating appliances and devices that generate electrical noise (for example, motors or fluorescent lamps).
- DO NOT expose it to direct sunlight or moisture.
- Avoid dropping the telephone or treating it roughly.
- Clean with a soft cloth.
- Never use a strong cleaning agent or abrasive powder because this can damage the finish.
- Retain the original packaging in case you need to ship it at a later date.

Important safety information



This symbol is to alert you to important operating or servicing instructions that may appear in this user's manual. Always follow basic safety precautions when using this product to reduce the risk of injury, fire, or electric shock.

Safety information

- Read and understand all instructions in the user's manual. Observe all markings on the product.
- Avoid using a telephone during a thunderstorm. There might be a slight chance of electric shock from lightning.
- Do not use a telephone in the vicinity of a gas leak. Under certain circumstances, a spark may be created when the adapter is plugged into the power outlet, or when the handset is replaced in its cradle. This is a common event associated with the closing of any electrical circuit. The user should not plug the phone into a power outlet, and should not put a charged handset into the cradle, if the phone is located in an environment containing concentrations of flammable or flame-supporting gases, unless there is adequate ventilation. A spark in such an environment could create a fire or explosion. Such environments might include: medical use of oxygen without adequate ventilation; industrial gases (cleaning solvents; gasoline vapors; etc.); a leak of natural gas; etc.
- Do not use this product near water, or when you are wet. For example, do not use it in a wet basement or shower, or next to a swimming pool, bathtub, kitchen sink, or laundry tub. Do not use liquids or aerosol sprays for cleaning. If the product comes in contact with any liquids, unplug any line or power cord immediately. Do not plug the product back in until it has dried thoroughly.
- Install this product in a protected location where no one can trip over any line or power cords. Protect cords from damage or abrasion.
- If this product does not operate normally, read **Troubleshooting** in this user's manual on pages 38-41. If you cannot solve the problem, or if the product is damaged, refer to **Limited warranty** on pages 46-47. Do not open this product except as may be directed in your user's manual. Opening the product or reassembling it incorrectly may expose you to hazardous voltages or other risks.
- If this product has replaceable batteries, replace batteries only as described in your user's manual on pages 4-5. Do not burn or puncture batteries—they contain caustic chemicals.
- If this product has a three-prong (grounding) plug or a polarized plug with one wide prong, it might not fit in outlets that are not polarized. Do not defeat the purpose of these plugs. If they do not fit in your outlet, the outlet should be replaced by an electrician.

SAVE THESE INSTRUCTIONS

FCC and ACTA information

If this equipment was approved for connection to the telephone network prior to July 23, 2001, it complies with Part 68 of the Federal Communications Commission (FCC) rules. If the equipment was approved after that date, it complies with the Part 68 rules and with the Technical Requirements for Connection of Equipment to the Telephone Network adopted by the Administrative Council for Terminal Attachments (ACTA). We are required to provide you with the following information.

1. Product identifier and REN information

The label on the back or bottom of this equipment contains, among other things, an identifier indicating product approval and the Ringer Equivalence Number (REN). This information must be provided to your telephone service provider upon request. For equipment approved prior to July 23, 2001, the product identifier is preceded by the phrase "FCC Reg No." and the REN is listed separately. For equipment approved after that date, the product identifier is preceded by "US" and a colon (:), and the REN is encoded in the product identifier without a decimal point as the sixth and seventh characters following the colon. For example, the product identifier US:AAAEQ03T123XYZ indicates the REN would be 0.3.

The REN is used to determine how many devices you can connect to your telephone line and still have them ring when you are called. In most, but not all areas, the sum of all RENS should be five (5.0) or less. You might want to contact your telephone service provider for more information.

2. Connection and use with the nationwide telephone network

The plug and jack used to connect this equipment to the premises wiring and the telephone network must comply with the applicable part 68 rules and technical requirements adopted by ACTA. A compliant telephone cord and modular plug is provided with this product. It is designed to be connected to a compatible modular wall jack that is also compliant. An RJ11 jack should normally be used for connecting to a single line and an RJ14 jack for two lines, see installation instructions in the user's manual. This equipment may not be used with coin telephone lines or with party lines. If you have specially wired alarm dialing equipment connected to your telephone line, ensure the connection of this equipment does not disable your alarm equipment. If you have questions about what will disable the alarm equipment, consult your telephone service provider or qualified installer.

3. Repair instructions

If this equipment is malfunctioning, it must be unplugged from the modular wall jack until the problem has been corrected. Repairs to this telephone equipment can only be made by the manufacturer or its authorized agents. For repair procedures, follow the instructions outlined under the limited warranty.

4. Rights of the telephone service provider

If this equipment is causing harm to the telephone network, the telephone service provider may temporarily discontinue your telephone service. The telephone service provider is required to notify you before interrupting service. If advance notice is not practical, you will be notified as soon as possible. You will be given the opportunity to correct the problem and the telephone service provider is required to inform you of your right to file a complaint with the FCC. Your telephone service provider may make changes in its facilities, equipment, operation, or procedures that could affect the proper functioning of this product. The telephone service provider is required to notify you if such changes are planned.

5. Hearing aid compatibility

If this product is equipped with a corded or cordless handset, it is hearing aid compatible.

FCC and ACTA information

6. Programming/testing of emergency numbers

If this product has memory dialing locations, you may choose to store police, fire department and emergency medical service telephone numbers in these locations. If you do, please keep three things in mind:

- a. We recommend that you also write the telephone number on the directory card (if applicable), so that you can still dial the emergency number manually if the memory dialing feature doesn't work.
- b. This feature is provided only as a convenience, and the manufacturer assumes no responsibility for customer reliance upon the memory feature.
- c. Testing the emergency telephone numbers you have stored is not recommended. However, if you do make a call to an emergency number:
 - You must remain on the line and briefly explain the reason for the call before hanging up.
 - Programming/testing of emergency numbers should be performed during off-peak hours, such as in the early morning or late evening, when the emergency services tend to be less busy.

Part 15 of FCC rules

Some telephone equipment generates, uses, and can radiate radio-frequency energy and, if not installed and used properly, may cause interference to radio and television reception. This product has been tested and found to meet the standards for a class B digital device, as specified in part 15 of the FCC rules.

These specifications are designed to provide reasonable protection against such interference in a residential installation. However, there is no guarantee that interference will not occur in a particular installation.

If this product causes interference to radio, VCR or television reception when it is in use, you might correct the interference with any one or all of these measures:

- Where it can be done safely, re-orient the receiving radio, VCR or television antenna.
- To the extent possible, relocate the radio, VCR, television or other receiver with respect to the telephone equipment.
- If this telephone product runs on AC power, plug your product into an AC outlet that's not on the same circuit as one used by your radio, VCR or television.
- Consult a dealer or an experienced radio/TV technician for help.

Modifications to this product, not expressly approved by the manufacturer, could void the user's authority to operate the equipment.

Limited warranty

The AT&T brand is used under license - any repair, replacement or warranty service, and all questions about this product should be directed to: In the United States of America, visit **www.telephones.att.com** or call **1 (800) 222-3111**. In Canada, call **1 (866) 288-4268**.

1. What does this limited warranty cover?

The manufacturer of this AT&T-branded product warrants to the holder of a valid proof of purchase ("CONSUMER" or "you") that the product and all accessories provided in the sales package ("PRODUCT") are free from defects in material and workmanship, pursuant to the following terms and conditions, when installed and used normally and in accordance with the PRODUCT operating instructions. This limited warranty extends only to the CONSUMER for products purchased and used in the United States of America and Canada.

2. What will be done if the PRODUCT is not free from defects in materials and workmanship during the limited warranty period ("materially defective PRODUCT")?

During the limited warranty period, the manufacturer's authorized service representative repairs or replaces at the manufacturer's option, without charge, a materially defective PRODUCT. If the manufacturer repairs the PRODUCT, they may use new or refurbished replacement parts. If the manufacturer chooses to replace the PRODUCT, they may replace it with a new or refurbished PRODUCT of the same or similar design. The manufacturer retains the defective parts, modules, or equipment. Repair or replacement of the PRODUCT, at the manufacturer's option, is your exclusive remedy. The manufacturer returns the repaired or replacement products to you in working condition. You should expect the repair or replacement to take approximately 30 days.

3. How long is the limited warranty period?

The limited warranty period for the PRODUCT extends for ONE (1) YEAR from the date of purchase. If the manufacturer repairs or replaces a materially defective PRODUCT under the terms of this limited warranty, this limited warranty also applies to repaired or replacement PRODUCT for a period of either (a) 90 days from the date the repaired or replacement PRODUCT is shipped to you or (b) the time remaining on the original one-year limited warranty; whichever is longer.

4. What is not covered by this limited warranty?

This limited warranty does not cover:

- PRODUCT that has been subjected to misuse, accident, shipping or other physical damage, improper installation, abnormal operation or handling, neglect, inundation, fire, water, or other liquid intrusion; or
- PRODUCT that has been damaged due to repair, alteration, or modification by anyone other than an authorized service representative of the manufacturer; or
- PRODUCT to the extent that the problem experienced is caused by signal conditions, network reliability or cable or antenna systems; or
- PRODUCT to the extent that the problem is caused by use with non-AT&T accessories; or
- PRODUCT whose warranty/quality stickers, PRODUCT serial number plates or electronic serial numbers have been removed, altered or rendered illegible; or
- PRODUCT purchased, used, serviced, or shipped for repair from outside the United States of America or Canada, or used for commercial or institutional purposes (including but not limited to products used for rental purposes); or
- PRODUCT returned without a valid proof of purchase (see item 6 below); or
- Charges for installation or setup, adjustment of customer controls, and installation or repair of systems outside the unit.

Limited warranty

5. How do you get warranty service?

To obtain warranty service in the United States of America, visit

www.telephones.att.com or call **1 (800) 222-3111**. In Canada, please dial **1 (866) 288-4268**.

NOTE: Before calling for service, please review the user's manual. A check of the PRODUCT's controls and features might save you a service call.

Except as provided by applicable law, you assume the risk of loss or damage during transit and transportation and are responsible for delivery or handling charges incurred in the transport of the PRODUCT(s) to the service location. The manufacturer will return repaired or replaced PRODUCT under this limited warranty. Transportation, delivery or handling charges are prepaid. The manufacturer assumes no risk for damage or loss of the PRODUCT in transit. If the PRODUCT failure is not covered by this limited warranty, or proof of purchase does not meet the terms of this limited warranty, the manufacturer notifies you and requests that you authorize the cost of repair prior to any further repair activity. You must pay for the cost of repair and return shipping costs for the repair of products that are not covered by this limited warranty.

6. What must you return with the PRODUCT to get warranty service?

You must:

- a. Return the entire original package and contents including the PRODUCT to the service location along with a description of the malfunction or difficulty; and
- b. Include a "valid proof of purchase" (sales receipt) identifying the PRODUCT purchased (PRODUCT model) and the date of purchase or receipt; and
- c. Provide your name, complete and correct mailing address, and telephone number.

7. Other limitations

This warranty is the complete and exclusive agreement between you and the manufacturer of this AT&T branded PRODUCT. It supersedes all other written or oral communications related to this PRODUCT. The manufacturer provides no other warranties for this PRODUCT. The warranty exclusively describes all of the manufacturer's responsibilities regarding the PRODUCT. There are no other express warranties. No one is authorized to make modifications to this limited warranty and you should not rely on any such modification.

State/Provincial Law Rights: This warranty gives you specific legal rights, and you might also have other rights that vary from state to state or province to province.

Limitations: Implied warranties, including those of fitness for a particular purpose and merchantability (an unwritten warranty that the PRODUCT is fit for ordinary use) are limited to one year from date of purchase. Some states/provinces do not allow limitations on how long an implied warranty lasts, so the above limitation might not apply to you. In no event shall the manufacturer be liable for any indirect, special, incidental, consequential, or similar damages (including, but not limited to lost profits or revenue, inability to use the PRODUCT or other associated equipment, the cost of substitute equipment, and claims by third parties) resulting from the use of this PRODUCT. Some states/provinces do not allow the exclusion or limitation of incidental or consequential damages, so the above limitation or exclusion might not apply to you.

Please retain your original sales receipt as proof of purchase.

Appendix

Technical specifications

Operating temperature	32°F — 122°F 0°C — 50°C
-----------------------	----------------------------

REN	1.0B
-----	------

Index

A

Answering a call, 15

Audio Assist[®], 19

B

Batteries, 4–5

C

Caller ID, 28–35

Call waiting, 17

Chain dialing, 18

Character chart, 20

Contrast, 12

D

Date and time, 11

Dial a directory number, 23

Dial a speed dial number, 26

Dialing pause, 21, 23, 25, 27

Dial mode, 12

Directory, 20–27

E

Ending a call, 15

H

Handset tab, 7, 9

Home area code, 13

I

Important safety information, 43

L

Language, 13

Last number redial, 16

Limited warranty, 46–47

Local area code, 14

M

Making a call, 15

Mute, 17

O

On-hook dialing (predialing), 15

P

Predialing, 15

Q

Quick reference guide, 1–2

R

Ringer volume, 16

S

Screen icons, 36

Speakerphone, 15

Speed dial, 25–27

T

Tabletop installation, 9

Technical specification, 48

Telephone installation, 6

Temporary tone dialing, 19

Troubleshooting, 38

V

Volume control, 17

W

Wall-mount installation, 7



www.telephones.att.com

Audio Assist[®] is a registered trademark of Advanced American Telephones.

© 2012 Advanced American Telephones. All Rights Reserved.

AT&T and the AT&T logo are trademarks of AT&T Intellectual Property licensed to
Advanced American Telephones, San Antonio, TX 78219.

Printed in China. Issue 1 AT&T 01/12.